



7500^{EXL}

RATED WATT

EXTENDED LIFE GENERATOR

Owner's Manual

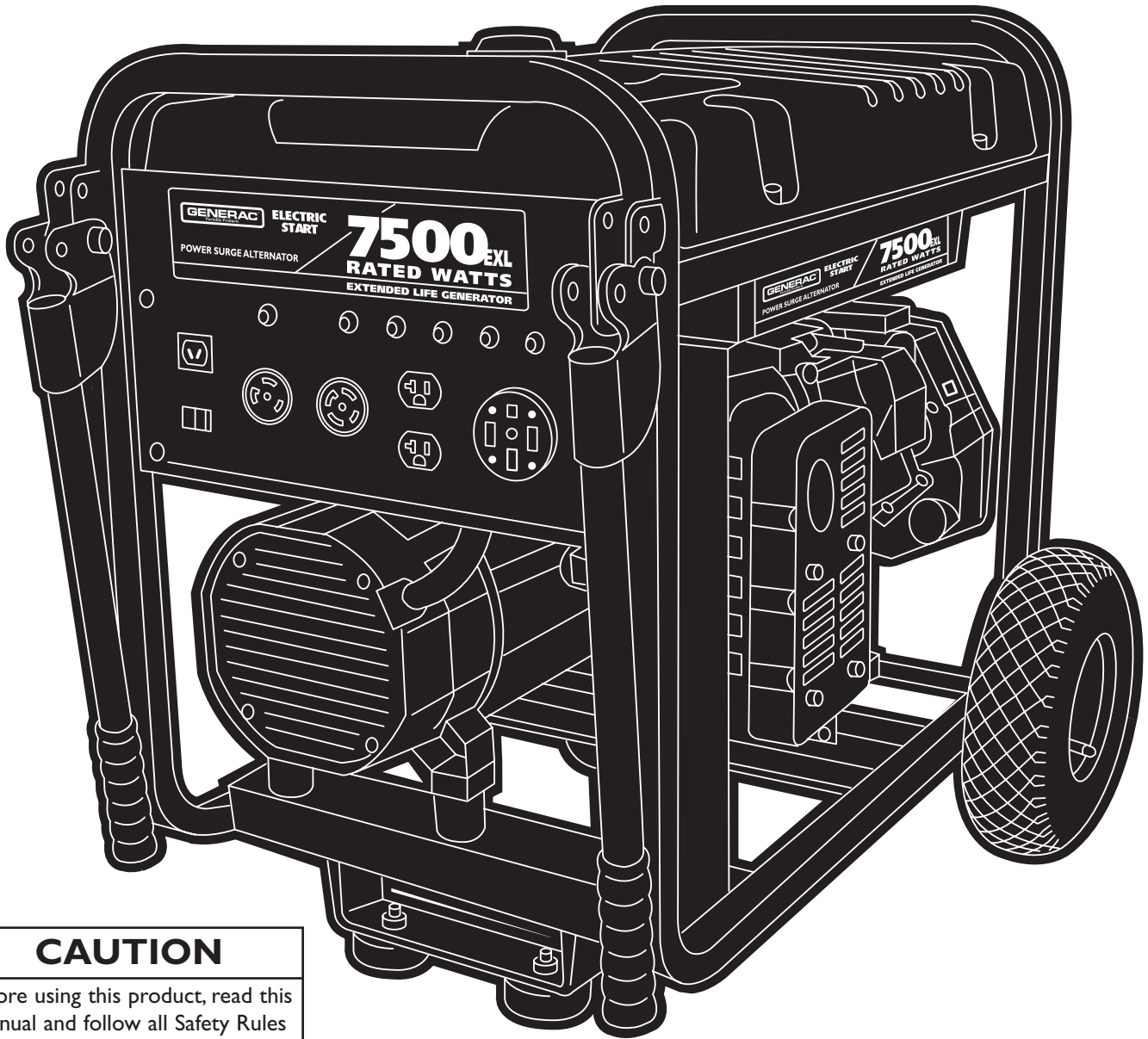

CAUTION

Before using this product, read this manual and follow all Safety Rules and Operating Instructions.

Questions? Help is just a moment away!

Call: **Generac Generator Helpline - 1-800-270-1408** M-F 8-5 CT
Web: www.generac-portables.com





SAVE THESE INSTRUCTIONS

TABLE OF CONTENTS

Safety Rules 2-4
 Know Your Generator 5
 Assembly 6-8
 Operation 9-16
 Maintenance 17
 Storage 18
 Troubleshooting 19
 Warranty 20

EQUIPMENT DESCRIPTION

 **Read this manual carefully and become familiar with your generator. Know its applications, its limitations and any hazards involved.**

The generators are an engine-driven, revolving field, alternating current (AC) generator. It was designed to supply electrical power for operating compatible electrical lighting, appliances, tools and motor loads. The generator's revolving field is driven at about 3,600 rpm by a single-cylinder engine.

CAUTION! DO NOT exceed the generator's wattage/ampere capacity. See "Don't Overload Generator".

Every effort has been made to ensure that information in this manual is accurate and current. However, we reserve the right to change, alter or otherwise improve the product and this document at any time without prior notice.

The Emission Control System for this generator is warranted for standards set by the Environmental Protection Agency. For warranty information refer to the engine owner's manual.

Copyright © 2005 Briggs & Stratton Power Products Group, LLC. All rights reserved. No part of this material may be reproduced or transmitted in any form by any means without the express written permission of Briggs & Stratton Power Products Group, LLC.

SAFETY RULES











 **This is the safety alert symbol. It is used to alert you to potential personal injury hazards. Obey all safety messages that follow this symbol to avoid possible injury or death.**

The safety alert symbol () is used with a signal word (DANGER, CAUTION, WARNING), a pictorial and/or a safety message to alert you to hazards. **DANGER** indicates a hazard which, if not avoided, will result in death or serious injury. **WARNING** indicates a hazard which, if not avoided, could result in death or serious injury. **CAUTION** indicates a hazard which, if not avoided, might result in minor or moderate injury. **CAUTION**, when used **without** the alert symbol, indicates a situation that could result in equipment damage. Follow safety messages to avoid or reduce the risk of injury or death.

 **WARNING**

The engine exhaust from this product contains chemicals known to the State of California to cause cancer, birth defects, or other reproductive harm.

Hazard Symbols and Meanings

		
Electrocution	Electrical Shock	Electrical Shock
		
Toxic Fumes	Explosion	Fire
		
Explosive Pressure	Chemical Burn	
		
Hot Surface	Kickback	

SAFETY RULES**7500EXL Extended Life Generator****GENERAC®**
Portable Products**⚠ DANGER**

Storage batteries give off explosive hydrogen gas during recharging.

Hydrogen gas stays near battery for a long time after battery has been charged.

Slightest spark will ignite hydrogen and cause explosion.

You can be blinded or severely injured.



Battery electrolyte fluid contains acid and is extremely caustic.

Contact with battery fluid will cause severe chemical burns.

- DO NOT allow any open flame, spark, heat, or lit cigarette during and for several minutes after charging a battery.
- Wear protective goggles, rubber apron, and rubber gloves.

⚠ WARNING

Running generator gives off carbon monoxide, an odorless, colorless, poison gas.

Breathing carbon monoxide will cause nausea, fainting or death.

- Operate generator ONLY outdoors.
- Keep exhaust gas from entering a confined area through windows, doors, ventilation intakes or other openings.
- DO NOT operate generator inside any building or enclosure, including the generator compartment of a recreational vehicle (RV).

⚠ WARNING

Generator produces powerful voltage.

Failure to isolate generator from power utility can result in death or injury to electric utility workers due to backfeed of electrical energy.

- When using generator for backup power, notify utility company. Use approved transfer equipment to isolate generator from electric utility.
- Use a ground circuit fault interrupter (GFCI) in any damp or highly conductive area, such as metal decking or steel work.
- DO NOT touch bare wires or receptacles.
- DO NOT use generator with electrical cords which are worn, frayed, bare or otherwise damaged.
- DO NOT operate generator in the rain.
- DO NOT handle generator or electrical cords while standing in water, while barefoot, or while hands or feet are wet.
- DO NOT allow unqualified persons or children to operate or service generator.

⚠ WARNING

Fuel and its vapors are extremely flammable and explosive.



Fire or explosion can cause severe burns or death.

WHEN ADDING OR DRAINING FUEL

- Turn generator OFF and let it cool at least 2 minutes before removing fuel cap. Loosen cap slowly to relieve pressure in tank.
- Fill or drain fuel tank outdoors.
- DO NOT overfill tank. Allow space for fuel expansion.
- Keep fuel away from sparks, open flames, pilot lights, heat, and other ignition sources.
- DO NOT light a cigarette or smoke.

WHEN STARTING EQUIPMENT

- Ensure spark plug, muffler, fuel cap and air cleaner are in place.
- DO NOT crank engine with spark plug removed.
- If fuel spills, wait until it evaporates before starting engine.

WHEN OPERATING EQUIPMENT

- Do not tip engine or equipment at angle which causes fuel to spill.
- This generator is not for use in mobile equipment or marine applications.

WHEN TRANSPORTING OR REPAIRING EQUIPMENT

- Transport/repair with fuel tank EMPTY or with fuel shutoff valve OFF.
- Disconnect spark plug wire.

WHEN STORING FUEL OR EQUIPMENT WITH FUEL IN TANK

- Store away from furnaces, stoves, water heaters, clothes dryers or other appliances that have pilot light or other ignition source because they can ignite fuel vapors.

⚠ WARNING

- This generator does not meet U. S. Coast Guard Regulation 33CFR-183 and should not be used on marine applications.
- Failure to use the appropriate U. S. Coast Guard approved generator could result in bodily injury and/or property damage.

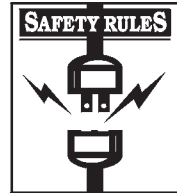

WARNING

 Rapid retraction of starter cord (kickback) will pull hand and arm toward engine faster than you can let go. Broken bones, fractures, bruises or sprains could result.

- When starting engine, pull cord slowly until resistance is felt and then pull rapidly to avoid kickback.
- NEVER start or stop engine with electrical devices plugged in and turned on.

WARNING

 Unintentional sparking can result in fire or electric shock.

WHEN ADJUSTING OR MAKING REPAIRS TO YOUR GENERATOR

- Disconnect the spark plug wire from the spark plug and place the wire where it cannot contact spark plug.

WHEN TESTING FOR ENGINE SPARK

- Use approved spark plug tester.
- DO NOT check for spark with spark plug removed.

WARNING

 Running engines produce heat. Temperature of muffler and nearby areas can reach or exceed 150°F (65°C).

 Severe burns can occur on contact. Combustible debris, such as leaves, grass, brush, ect. can catch fire.

- DO NOT touch hot surfaces.
- Allow equipment to cool before touching.
- The generator must be at least 5 feet from structures having combustible walls and/or other combustible materials.
- Keep at least 3 feet of clearance on all sides of generator for adequate cooling, maintenance and servicing.
- In the State of California a spark arrester is required by law (Section 4442 of the California Public Resources Code). Other states may have similar laws. Federal laws apply on federal lands. If you equip the muffler with a spark arrester, it must be maintained in effective working order.

CAUTION

Excessively high operating speeds increase risk of injury and damage to generator. Excessively low speeds impose a heavy load.

- DO NOT tamper with governed speed. Generator supplies correct rated frequency and voltage when running at governed speed.
- DO NOT modify generator in any way.

CAUTION

Exceeding generators wattage/amperage capacity can damage generator and/or electrical devices connected to it.

- See “Don’t Overload Generator”.
- Start generator and let engine stabilize before connecting electrical loads.
- Connect electrical loads in OFF position, then turn ON for operation.
- Turn electrical loads OFF and disconnect from generator before stopping generator.

CAUTION

Improper treatment of generator can damage it and shorten its life.

- Use generator only for intended uses.
- If you have questions about intended use, ask dealer or call 1-800-270-1408.
- Operate generator only on level surfaces.
- DO NOT expose generator to excessive moisture, dust, dirt, or corrosive vapors.
- DO NOT insert any objects through cooling slots.
- If connected devices overheat, turn them off and disconnect them from generator.
- Shut off generator if:
 - electrical output is lost;
 - equipment sparks, smokes, or emits flames;
 - unit vibrates excessively.



KNOW YOUR GENERATOR

Read this owner's manual and safety rules before operating your generator.

Compare the illustrations with your generator, to familiarize yourself with the locations of various controls and adjustments. Save this manual for future reference.

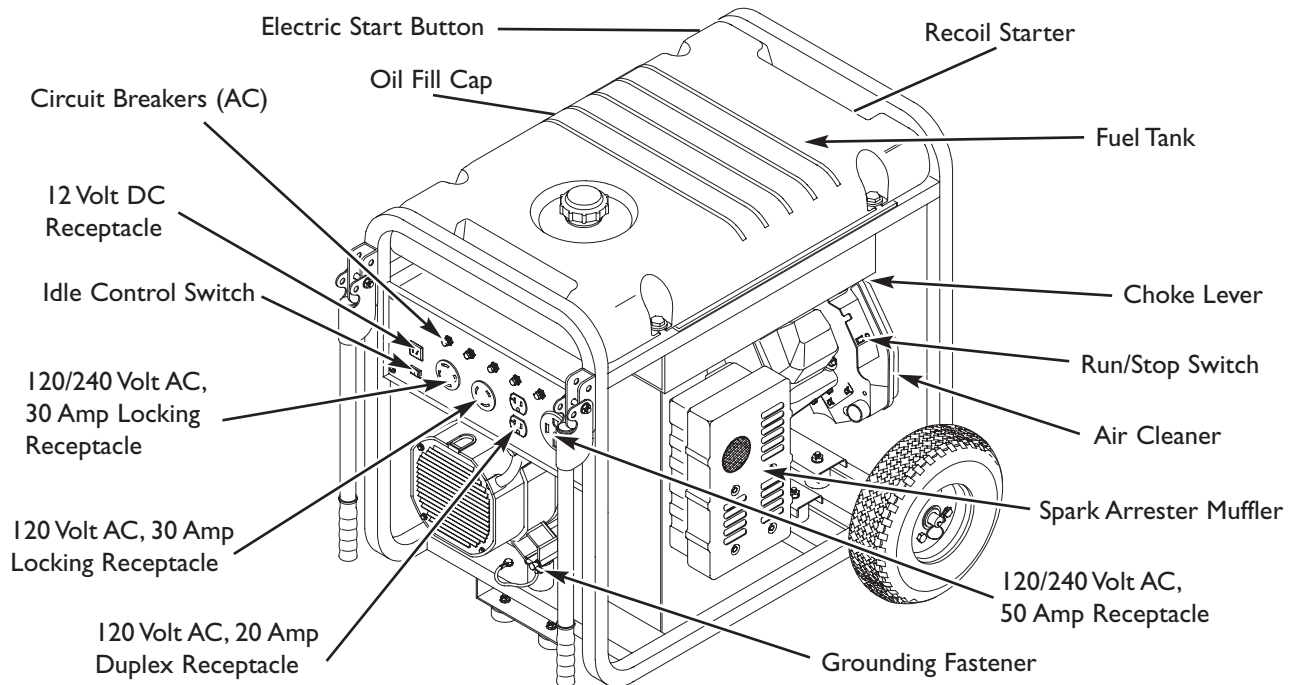

12 Volt DC Receptacle — Use this receptacle with battery charge cables to charge a 12 Volt battery.

120 Volt AC, 20 Amp Duplex Receptacle — May be used to supply electrical power for the operation of 120 Volt AC, single phase, 60 Hz electrical lighting, appliance, tool and motor loads.

120 Volt AC, 30 Amp Locking Receptacle — May be used to supply electrical power for the operation of 120 Volt AC, 30 Amp, single phase, 60 Hz electrical lighting, appliance, tool and motor loads.

120/240 Volt AC, 30 Amp Locking Receptacle — May be used to supply electrical power for the operation of 120 and/or 240 Volt AC, 30 Amp, single phase, 60 Hz electrical lighting, appliance, tool and motor loads.

120/240 Volt AC, 50 Amp Receptacle — May be used to supply electrical power for the operation of 240 Volt AC, 50 Amp, single phase, 60 Hz electrical loads.

Air Cleaner — Protects engine by filtering dust and debris out of intake air.

Choke Lever — Used when starting a cold engine.

Circuit Breakers (AC) — Each receptacle is provided with a "push to reset" circuit breaker to protect the generator against electrical overload.

Fuel Tank — Capacity of seven (7) U.S. gallons.

Electric Start Switch — Press to start the engine.

Grounding Fastener — If required, please consult a qualified electrician, electrical inspector, or local agency having jurisdiction.

Idle Control Switch — The idle control runs the engine at normal (high) speeds when there is a load present and runs the engine at idle (low) speeds when a load is not present.

Oil Fill Cap — Add oil to engine here.

Recoil Starter — Used to start the engine manually.

Run/Stop Switch — Must be in "Run" position to start engine. Set to "Stop" to stop a running engine.

Spark Arrester Muffler — Exhaust muffler lowers engine noise and is equipped with a spark arrester screen.

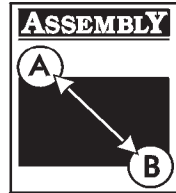

ASSEMBLY

Your generator requires some assembly and is ready for use after it has been properly serviced with the recommended oil and fuel.

If you have any problems with the assembly of your generator, please call the generator helpline at 1-800-270-1408.

Remove Generator From Carton

1. Set carton on a rigid flat surface with "This Side Up" arrows pointing upward.
2. Carefully open top flaps of shipping carton. Review "Cold Weather Operation" on page 12.
3. Cut down corners at one end of carton from top to bottom and lay that side of carton down flat.
4. Remove all packing material, carton fillers, etc.
5. Remove the generator from the shipping carton.

Carton Contents

Check all contents against those listed below:

- Generator
- Wheel kit

- Storage Cover
 - Adapter Cord Set
 - Battery
 - Battery Float Charger
 - Battery Charge Cables
 - Spare Spark Plug, Air Filter, and Oil Filter
 - Spark Plug Wrench
 - (2) Locking 30 Amp Plugs
 - Engine Oil
 - Owner's Manual
 - Engine Manual
- If any parts are missing or damaged, call the generator helpline at **1-800-270-1408**.

Install Wheel Kit

The wheel kit is designed to greatly improve the portability of your generator.

NOTE: Wheel kit is not intended for over-the-road use. You will need a socket wrench with 1/2" or 13mm sockets and a needle-nose plier to install this kit.

Refer to Figure 1 and install the wheel kit as follows:

1. Place the bottom of the generator cradle on a flat, even surface. Temporarily place unit on blocks to ease assembly.

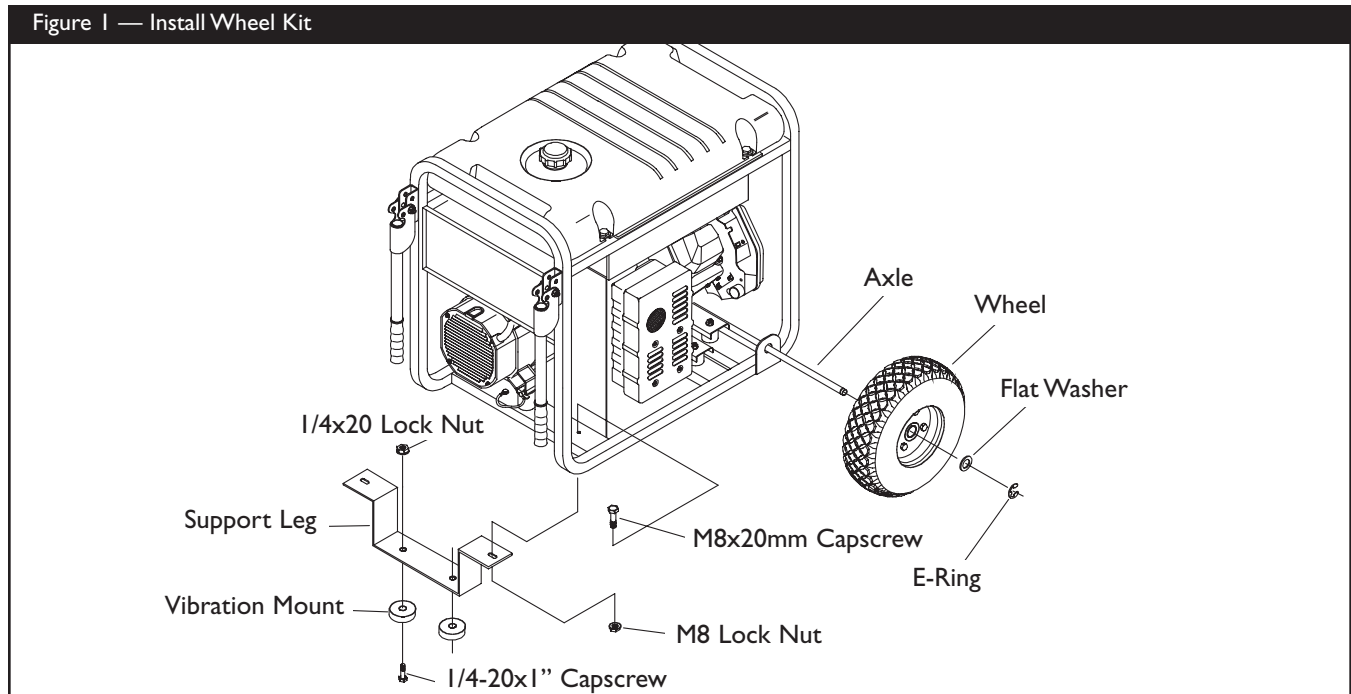

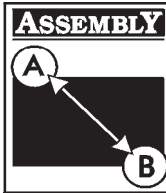

- Slide axle through both axle mounting brackets on cradle frame, as shown in Figure 1.
- Slide a wheel over the axle.

NOTE: Be sure to install both wheels with the air pressure valve on the outboard side.

- Place the e-ring onto the groove in the axle. You may add the flat washer if desired.
- Place one end of the needle nose pliers on the bottom of the axle and the other end of the pliers on top of the e-ring. Seat the e-ring by pressing the pliers closed.
- Repeat step 3 through 5 to secure second wheel.
- Remove the temporary blocks.
- Attach the vibration mounts to the support leg with 1/4-20x1" capscrews and 1/4-20 lock nuts.
- With the wheels on, you can now lift up the handle end and attach the support leg with M8x20mm capscrews and M8 lock nuts.
- Check that all fasteners are tight and the tires are inflated to the value marked on the tire or within 15 and 40 psi.

Check Battery / Attach Negative Battery Wire

The sealed battery on the generator is fully charged and pre-installed except for the negative (black) battery cable.

To install:

- Cut off tie wrap securing loose end of negative (black) cable.
- Remove nut and washer on negative battery terminal.
- Slide negative battery cable over screw on negative terminal (Figure 2).

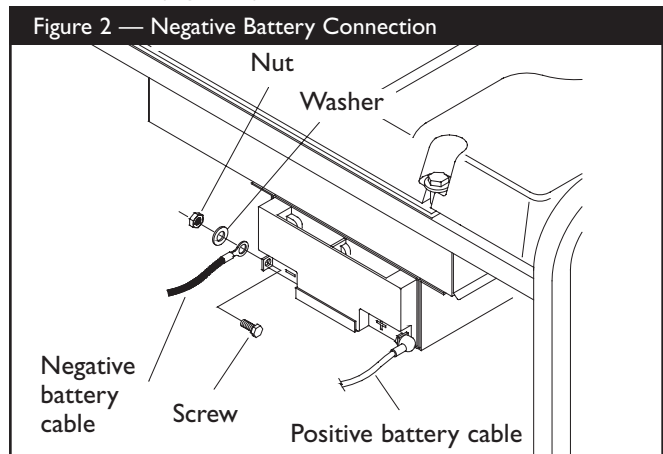

- Reattach washer and nut and tighten.
- Verify that connections to battery and generator are tight and secure.

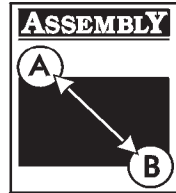

BEFORE STARTING THE ENGINE

Add Engine Oil

- Place generator on a level surface.

CAUTION

Any attempt to crank or start the engine before it has been properly filled with the recommended oil will result in equipment failure.

- Refer to engine manual for oil fill information.
 - Damage to equipment resulting from failure to follow this instruction will void warranty.
- Refer to engine owner's manual and follow oil recommendations and instructions.

NOTE: Check oil often during engine break-in. Refer to engine owner's manual for recommendations.

NOTE: The generator assembly rotates on a prelubricated and sealed ball bearing that requires no additional lubrication for the life of the bearing.

Add Fuel

NOTE: This gasoline engine is certified to operate on gasoline. Exhaust Emission Control System: EM (Engine Modifications).

WARNING



Fuel and its vapors are extremely flammable and explosive.



Fire or explosion can cause severe burns or death.

WHEN ADDING FUEL

- Turn generator OFF and let it cool at least 2 minutes before removing fuel cap. Loosen cap slowly to relieve pressure in tank.
- Fill fuel tank outdoors.
- DO NOT overfill tank. Allow space for fuel expansion.
- Keep fuel away from sparks, open flames, pilot lights, heat, and other ignition sources.
- DO NOT light a cigarette or smoke.

- Use clean, fresh, regular UNLEADED fuel with a minimum of 85 octane. DO NOT use fuel which contains Methanol. DO NOT mix oil with fuel.
- Clean area around fuel fill cap, remove cap.
- Slowly add regular unleaded fuel to fuel tank. Be careful not to overfill. Allow about 1.5" of tank space for fuel expansion (Figure 3).

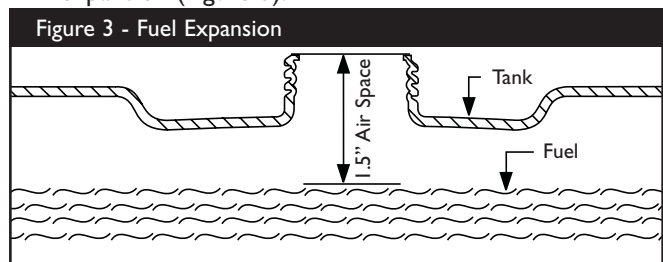

- Install fuel cap and wipe up any spilled fuel.



USING THE GENERATOR

System Ground

The generator has a system ground that connects the generator frame components to the ground terminals on the AC output receptacles. The system ground is connected to the AC neutral wire (see “Equipment Description”, earlier in this manual).

Special Requirements

There may be Federal or State Occupational Safety and Health Administration (OSHA) regulations, local codes, or ordinances that apply to the intended use of the generator. Please consult a qualified electrician, electrical inspector, or the local agency having jurisdiction.

- In some areas, generators are required to be registered with local utility companies.
- If the generator is used at a construction site, there may be additional regulations which must be observed.

Connecting to a Building's Electrical System

Connections for standby power to a building's electrical system must be made by a qualified electrician. The connection must isolate the generator power from utility power, and must comply with all applicable laws and electrical codes.

WARNING



Generator produces powerful voltage. Failure to isolate generator from power utility can result in death or injury to electric utility workers due to backfeed of electrical energy.

- When using generator for backup power, notify utility company. Use approved transfer equipment to isolate generator from electric utility.
- Use a ground fault circuit interrupter (GFCI) in any damp or highly conductive area, such as metal decking or steel work.
- DO NOT touch bare wires or receptacles.
- DO NOT use generator with electrical cords which are worn, frayed, bare or otherwise damaged.
- DO NOT operate generator in the rain.
- DO NOT handle generator or electrical cords while standing in water, while barefoot, or while hands or feet are wet.
- DO NOT allow unqualified persons or children to operate or service generator.

Generator Location

Generator Clearance

WARNING



Running generator gives off carbon monoxide, an odorless, colorless, poison gas. Breathing carbon monoxide will cause nausea, fainting or death.

- Operate generator **ONLY** outdoors.
- Keep exhaust gas from entering a confined area through windows, doors, ventilation intakes or other openings.
- **DO NOT** operate generator inside any building or enclosure, including the generator compartment of a recreational vehicle (RV).

The generator must be at least 5 ft. (152 cm) from structures having combustible walls and/or other combustible materials. Leave at least 3 ft. (92 cm) all around generator including overhead, for adequate cooling, maintenance and servicing.

Place generator in a well ventilated area, which will allow for removal of deadly exhaust gas. **DO NOT** place generator where exhaust gas could accumulate and enter inside or be drawn into a potentially occupied building. Ensure exhaust gas is kept away from any windows, doors, ventilation intakes or other openings that can allow exhaust gas to collect in a confined area (Figure 4). Prevailing winds and air currents should be taken into consideration when positioning generator.

Figure 4 — Generator Clearance

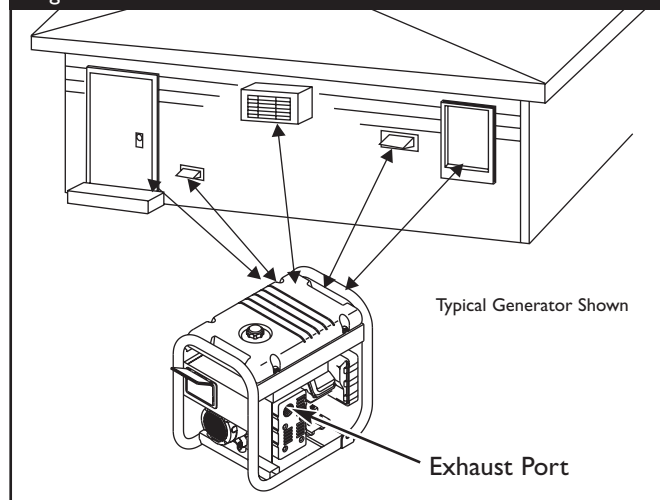



OPERATING THE GENERATOR

CAUTION

Exceeding generators wattage/amperage capacity can damage generator and/or electrical devices connected to it.

- See “Don’t Overload Generator”.
- Start generator and let engine stabilize before connecting electrical loads.
- Connect electrical loads in OFF position, then turn ON for operation.
- Turn electrical loads OFF and disconnect from generator before stopping generator.

IMPORTANT: Always unplug the battery float charger before starting the generator.

Starting the Engine

Disconnect all electrical loads from the generator. Use the following start instruction steps by numerical order:

1. Make sure unit is on a level surface.

IMPORTANT: Failure to start and operate unit on a level surface will cause the unit not to start or shut down during operation.

2. Turn the fuel valve to the “On” position (Figure 5). The fuel valve handle should be vertical (pointing toward the ground) for fuel to flow.

Figure 5 — Fuel Valve

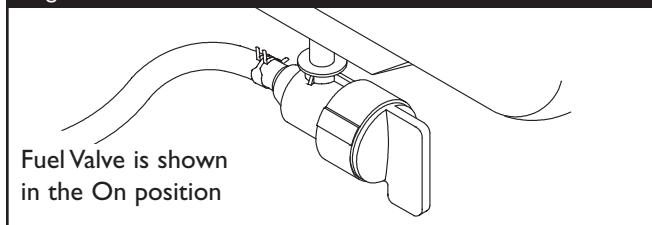

3. Make sure the Idle Control switch is in “Off” position (Figure 6).

Figure 6 — Idle Control Switch

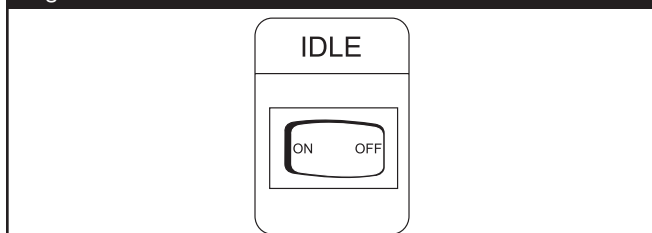

4. Start the engine according to instructions given in the engine owner’s manual.

WARNING



Rapid retraction of starter cord (kickback) will pull hand and arm toward engine faster than you can let go.

Broken bones, fractures, bruises or sprains could result.

- When starting engine, pull cord slowly until resistance is felt and then pull rapidly to avoid kickback.
- NEVER start or stop engine with electrical devices plugged in and turned on.

NOTE: If engine starts after 3 pulls but fails to run, or if unit shuts down during operation, make sure unit is on a level surface and check for proper oil level in crankcase. This unit may be equipped with a low oil protection device. See engine manual.

WARNING



Running engines produce heat. Temperature of muffler and nearby areas can reach or exceed 150°F (65°C).



Severe burns can occur on contact.

Combustible debris, such as leaves, grass, brush, ect. can catch fire.

- DO NOT touch hot surfaces.
- Allow equipment to cool before touching.
- The generator must be at least 5 feet from structures having combustible walls and/or other combustible materials.
- Keep at least 3 feet of clearance on all sides of generator for adequate cooling, maintenance and servicing.
- In the State of California a spark arrester is required by law (Section 4442 of the California Public Resources Code). Other states may have similar laws. Federal laws apply on federal lands. If you equip the muffler with a spark arrester, it must be maintained in effective working order.

Connecting Electrical Loads

- Let engine stabilize and warm up for a few minutes after starting.
- Plug in and turn on the desired 120 and/or 240 Volt AC, single phase, 60 Hz electrical loads.
- DO NOT connect 240 Volt loads to the 120 Volt receptacles.
- DO NOT connect 3-phase loads to the generator.
- DO NOT connect 50 Hz loads to the generator.
- **DO NOT OVERLOAD THE GENERATOR.** See “Don’t Overload Generator”.



Stopping the Engine

1. Turn off and unplug **all** electrical loads from generator panel receptacles. NEVER start or stop engine with electrical devices plugged in and turned on.
2. Put idle control switch in “**Off**” position.
3. Let engine run at no-load for 30 seconds to stabilize internal temperatures of engine and generator.
4. Turn engine off according to instructions given in engine owner’s manual.
5. Move fuel valve to “**Off**” position.

Operating Automatic Idle Control

This switch is designed to greatly improve fuel economy. **When this switch is turned ON**, the engine will only run at its normal high governed engine speed when an electrical load is connected. When an electrical load is removed, the engine will run at a reduced speed. **With the switch off**, the engine will run at the normal high engine speed. **Always have the switch off when starting and stopping the engine.**

Charging a Battery

Your generator has the capability of recharging a discharged 12 Volt automotive or utility style storage battery. **DO NOT** use the unit to charge any 6 Volt batteries. **DO NOT** use the unit to crank an engine having a discharged battery.

DANGER

 Storage batteries give off explosive hydrogen gas during recharging.

Hydrogen gas stays near battery for a long time after battery has been charged.

Slightest spark will ignite hydrogen and cause explosion.

You can be blinded or severely injured.

 Battery electrolyte fluid contains acid and is extremely caustic.

Contact with battery fluid will cause severe chemical burns.

- **DO NOT** allow any open flame, spark, heat, or lit cigarette during and for several minutes after charging a battery.
- Wear protective goggles, rubber apron, and rubber gloves.

To recharge 12 Volt batteries, proceed as follows:

1. Check fluid level in all battery cells. If necessary, add **ONLY** distilled water to cover separators in battery cells. **DO NOT** use tap water.
2. If battery is equipped with vent caps, make sure they are installed and are tight.
3. If necessary, clean battery terminals.
4. Connect battery charge cable connector plug to panel receptacle identified by the words “12-VOLTS D.C.”
5. Connect battery charge cable clamp with **red** handle to the **positive (+)** battery terminal (Figure 7).

Figure 7 — Battery Connections

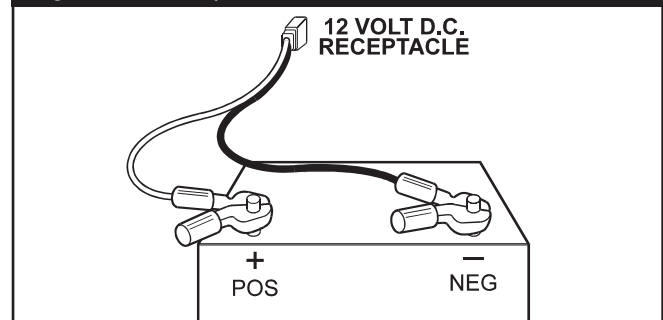

6. Connect battery charge cable clamp with **black** handle to the **negative (-)** battery terminal (Figure 7).
7. Start engine. Let engine run while battery recharges.
8. When battery has charged, shut down engine

NOTE: Use an automotive hydrometer to test battery state of charge and condition. Follow the hydrometer manufacturer’s instructions carefully. Generally, a battery is considered to be at 100% state of charge when specific gravity of its fluid (as measured by hydrometer) is 1.260 or higher.



How to Use the Battery Charger

Use battery float charger jack to keep the starting battery charged and ready for use. Battery charging should be done in a dry location, such as inside a garage.

- Plug the charger into the unit's "Battery Float Charger" jack, which is located on the starter switch (Figure 8). Plug battery charger into a 120 Volt AC wall receptacle.

Figure 8 — Battery Charger Jack

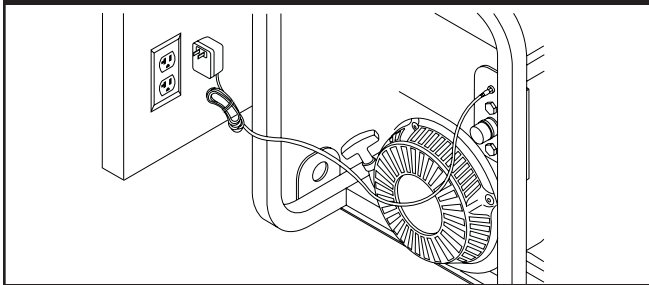

- Unplug the charger from the unit and the wall outlet when generator is being started and while it is in operation.
- Keep this charger plugged in when generator is not in use to prolong battery life. The charger has a built in float equalizer and will not overcharge the battery, even when plugged in for an extended period of time.

IMPORTANT: See "Battery Maintenance" on page 17 for additional information.

COLD WEATHER OPERATION

Under certain weather conditions (temperatures below 40°F [4°C] combined with high humidity), your generator may experience icing of the carburetor and/or the crankcase breather system. To reduce this problem, you need to perform the following:

1. Make sure generator has clean, fresh fuel.
2. Open fuel valve (turn valve to open position).
3. Use SAE 5W-30 oil (synthetic preferred, see engine manual).
4. Check oil level daily or after every eight (8) hours of operation.
5. Maintain generator following "Maintenance Schedule" in engine manual.
6. Shelter unit from elements.



In an emergency, use the original shipping carton as a temporary shelter:

7. Cut off all carton flaps.
8. Cut out one long side of carton to expose muffler side of unit as shown in Figure 9.

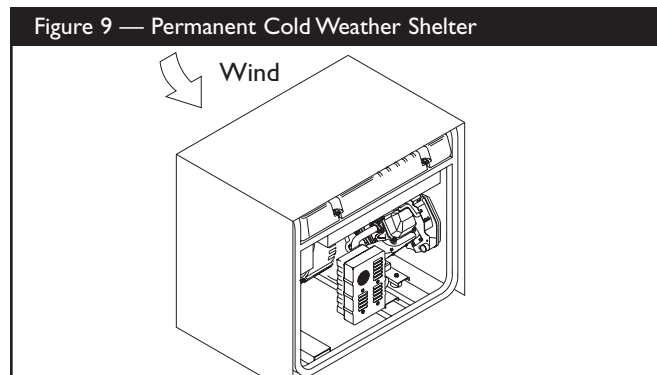

IMPORTANT: The generator must be at least 5 ft. (152 cm) from structures having combustible walls and/or other combustible materials. Leave at least 3 ft. (92 cm) all around generator including overhead, for adequate cooling, maintenance and servicing.

WARNING	
	Running engines produce heat. Temperature of muffler and nearby areas can reach or exceed 150°F (65°C).
	Severe burns can occur on contact. Combustible debris, such as leaves, grass, brush, ect. can catch fire.
<ul style="list-style-type: none">• DO NOT touch hot surfaces.• Allow equipment to cool before touching.• The generator must be at least 5 feet from structures having combustible walls and/or other combustible materials.• Keep at least 3 feet of clearance on all sides of generator for adequate cooling, maintenance and servicing.• Remove shelter when temperatures are above 40°F [4°C].	

9. Cut appropriate slots to access receptacles of unit.
10. Start unit, then place carton over it.

NOTE: Remove shelter when temperatures are above 40°F [4°C].

For a more permanent shelter, build a structure that will enclose three sides and the top of the generator.

7. Make sure entire muffler-side of generator is exposed, as shown in Figure 9.

IMPORTANT: The generator must be at least 5 ft. (152 cm) from structures having combustible walls and/or other combustible materials. Leave at least 3 ft. (92 cm) all around generator including overhead, for adequate cooling, maintenance and servicing.

8. Face exposed end away from wind and elements.
9. Structure should hold enough heat created by the generator to prevent icing problem.
10. Start and run engine outdoors.
11. Keep exhaust gas from entering a confined area through windows, doors, ventilation intakes or other openings.

WARNING	
	Running generator gives off carbon monoxide, an odorless, colorless, poison gas. Breathing carbon monoxide will cause nausea, fainting or death.
<ul style="list-style-type: none">• Operate generator ONLY outdoors.• Keep exhaust gas from entering a confined area through windows, doors, ventilation intakes or other openings.• DO NOT operate generator inside any building or enclosure, including the generator compartment of a recreational vehicle (RV).	

12. DO NOT enclose generator any more than shown in Figure 9.
13. Remove shelter when temperatures are above 40°F [4°C].
14. Turn engine OFF and let cool two (2) minutes before refueling.

GENERATOR ADAPTER CORD SET

The generator is equipped with a 25' generator adapter cord set designed for a 240 Volt, 30 Amp grounded neutral circuit (Figure 10). The generator adapter cord set provides a convenient supply of emergency power into your dwelling so that your generator can be operated safely outside.

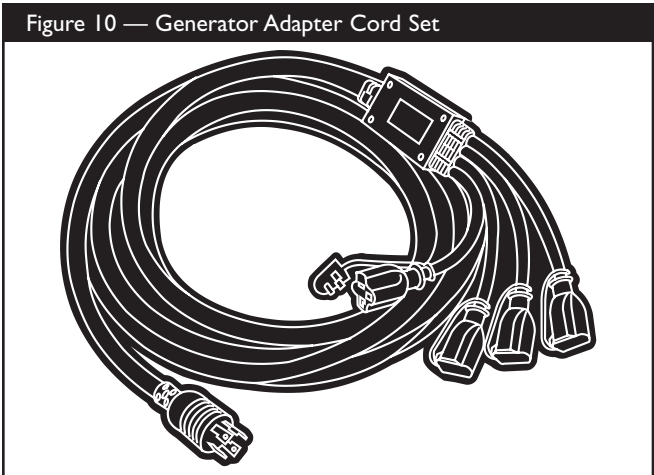

The maximum load on each outlet is 20 Amps. The maximum total load on both yellow wire outlets or both black wire outlets is 30 Amps.

NOTE: Follow all safety precautions when connecting any extension cord or device to the generator.

RECEPTACLES

CAUTION

Receptacles may be marked with rating value greater than generator output capacity.

- NEVER attempt to power a device requiring more amperage than generator or receptacle can supply.
- DO NOT overload the generator. See “Don’t Overload Generator”.

12 Volt DC, 10 Amp Receptacle

This receptacle allows you to recharge a 12 Volt automotive or utility style storage battery with the battery charge cables provided (Figure 11).

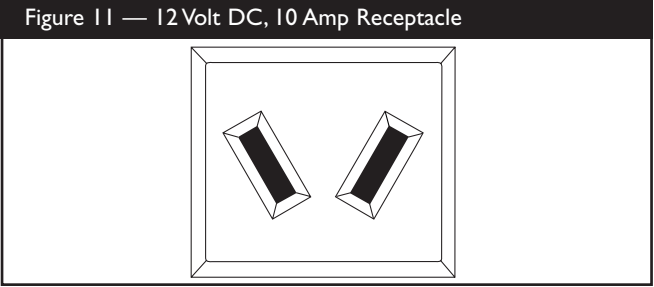

This receptacle can not recharge 6 Volt batteries and can not be used to crank an engine having a discharged battery. See the section “Charging a Battery” (page 11) before attempting to recharge a battery.

120 Volt AC, 20 Amp, Duplex Receptacle

Each receptacle (Figure 12) is protected against overload by a 20 Amp push-to-reset circuit breaker.

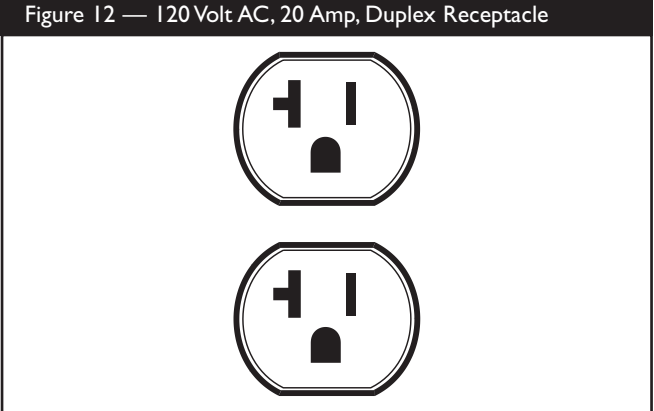

Use each receptacle to operate 120 Volt AC, single-phase, 60 Hz electrical loads requiring up to 2,400 watts (2.4 kW) at 20 Amps of current. Use cord sets that are rated for 125 Volt AC loads at 20 Amps (or greater).

120 Volt AC, 30 Amp Locking Receptacle

Use a NEMA L5-30 plug with this receptacle. Connect a 3-wire cord set rated for 125 Volt AC loads at 30 Amps to the plug (Figure 13).



Figure 13 — 120 Volt AC, 30 Amp, Locking Receptacle

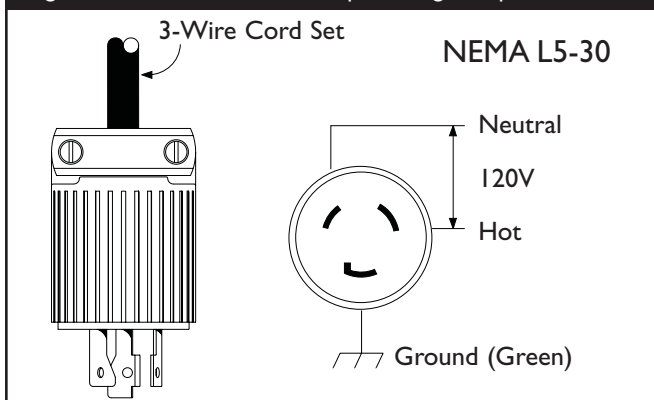

Use this receptacle to operate 120 Volt AC, 60 Hz, single phase loads requiring up to 3,600 watts (3.6 kW) of power at 30 Amps. The outlet is protected by a 30 Amp push-to-reset circuit breaker.

120/240 Volt AC, 30 Amp, Locking Receptacle

Use a NEMA L14-30 plug with this receptacle. Connect a 4-wire cord set rated for 250 Volt AC loads at 30 Amps (or greater) (Figure 14). You can use the same 4-wire cord if you plan to run a 120 Volt load.

Figure 14 — 120/240 Volt AC, 30 Amp Receptacle

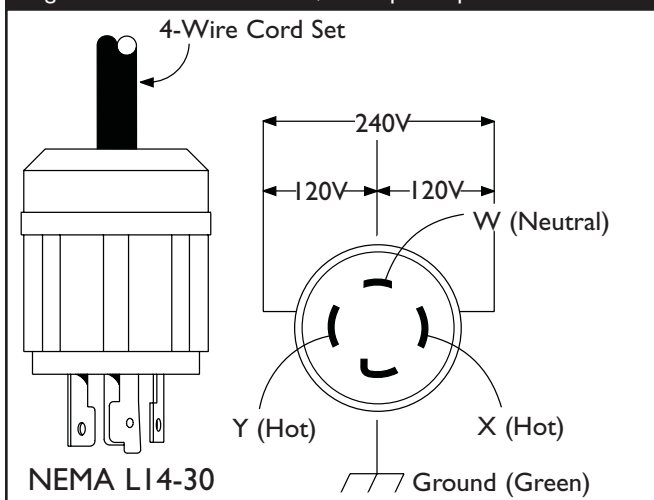

This receptacle powers 120/240 Volt AC, 60 Hz, single phase loads requiring up to 3,600 watts of power at 30 Amps for 120 Volts; 7,200 watts of power (7.2 kW) at 30 Amps for 240 Volts. The outlet is protected by a 30 Amp push-to-reset circuit breaker.

120/240 Volt AC, 50 Amp Receptacle

Use a NEMA 14-50 plug with this receptacle (Figure 15). Connect a 4-wire cord set rated for 250 Volt AC loads at 50 Amps to the plug.

Figure 15 — 120/240 Volt AC, 50 Amp Receptacle

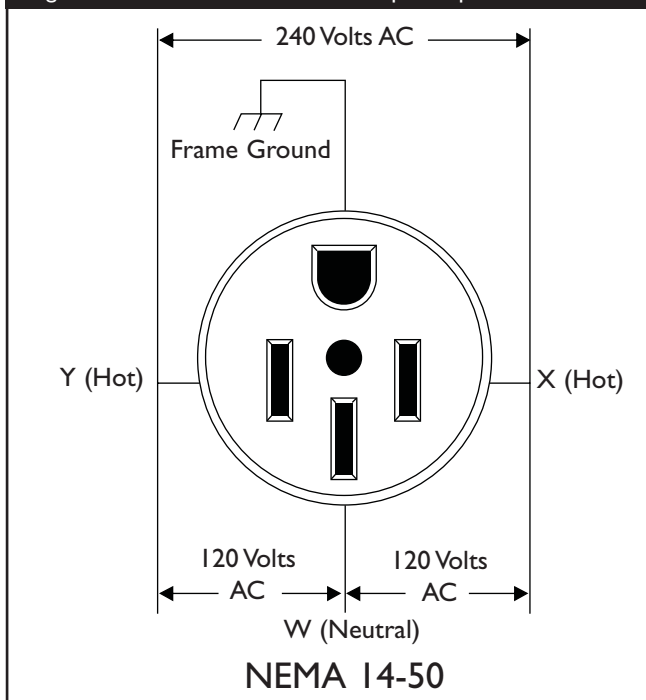

Use this receptacle to operate 120/240 Volt AC, 60 Hz, single phase loads requiring up to 7,500 watts (7.5 kW) of power. The outlet is protected by a 35 Amp push-to-reset circuit breaker.



DON'T OVERLOAD GENERATOR

Capacity

You must make sure your generator can supply enough rated (running) and surge (starting) watts for the items you will power at the same time. Follow these simple steps:

1. Select the items you will power at the same time.
2. Total the rated (running) watts of these items. This is the amount of power your generator must produce to keep your items running. See Figure 16.
3. Estimate how many surge (starting) watts you will need. Surge wattage is the short burst of power needed to start electric motor-driven tools or appliances such as a circular saw or refrigerator. Because not all motors start at the same time, total surge watts can be estimated by adding only the item(s) with the highest additional surge watts to the total rated watts from step 2.

Example:

Tool or Appliance	Rated (Running) Watts	Additional Surge (Starting) Watts
Window Air Conditioner	1200	1800
Refrigerator	800	1600
Deep Freezer	500	500
Television	500	-
Light (75 Watts)	75	-
	3075 Total Running Watts	1800 Highest Surge Watts

Total Rated (Running) Watts = 3075
 Highest Additional Surge Watts = 1800
 Total Generator Output Required = 4875

Power Management

To prolong the life of your generator and attached devices, it is important to take care when adding electrical loads to your generator. There should be nothing connected to the generator outlets before starting its engine. The correct and safe way to manage generator power is to sequentially add loads as follows:

1. With nothing connected to the generator, start the engine as described in this manual.
2. Plug in and turn on the first load, preferably the largest load you have.
3. Permit the generator output to stabilize (engine runs smoothly and attached device operates properly).

4. Plug in and turn on the next load.
5. Again, permit the generator to stabilize.
6. Repeat steps 4 and 5 for each additional load.

NEVER add more loads than the generator capacity. Take special care to consider surge loads in generator capacity, as described above.

Figure 16 - Wattage Reference Chart

Tool or Appliance	Rated* (Running) Watts	Additional Surge (Starting) Watts
Essentials		
Light Bulb - 75 watt	75	-
Deep Freezer	500	500
Sump Pump	800	1200
Refrigerator/Freezer - 18 Cu. Ft.	800	1600
Water Well Pump - 1/3 HP	1000	2000
Heating/Cooling		
Window AC - 10,000 BTU	1200	1800
Window Fan	300	600
Furnace Fan Blower - 1/2 HP	800	1300
Kitchen		
Microwave Oven - 1000 Watt	1000	-
Coffee Maker	1500	-
Electric Stove - Single Element	1500	-
Hot Plate	2500	-
Family Room		
DVD/CD Player	100	-
VCR	100	-
Stereo Receiver	450	-
Color Television - 27"	500	-
Personal Computer w/17" monitor	800	-
Other		
Security System	180	-
AM/FM Clock Radio	300	-
Garage Door Opener - 1/2 HP	480	520
Electric Water Heater - 40 Gallon	4000	-
DIY/Job Site		
Quartz Halogen Work Light	1000	-
Airless Sprayer - 1/3 HP	600	1200
Reciprocating Saw	960	960
Electric Drill - 1/2 HP	1000	1000
Circular Saw - 7 1/4"	1500	1500
Miter Saw - 10"	1800	1800
Planer/Joiner - 6"	1800	1800
Table Saw/Radial Arm Saw - 10"	2000	2000
Air Compressor - 1-1/2 HP	2500	2500

*Wattages listed are approximate only. Check tool or appliance for actual wattage.



7500EXL Extended Life Generator



SPECIFICATIONS

- Maximum Surge Watts13,500 watts
- Continuous Wattage Capacity7,500 watts
- Power Factor1.0
- Rated Maximum Continuous AC Load Current:
 - At 120 Volts62.5 Amps
 - At 240 Volts31.2 Amps
- Phase1-phase
- Rated Frequency60 Hertz
- Fuel Tank Capacity7 U.S. gallons
- Shipping Weight240 lbs.

GENERAL MAINTENANCE RECOMMENDATIONS

The Owner/Operator is responsible for making sure that all periodic maintenance tasks are completed on a timely basis; that all discrepancies are corrected; and that the unit is kept clean and properly stored. **NEVER operate a damaged or defective generator.**

NOTE: Should you have questions about replacing components on your Generac Portable Products generator, please call **1-800-270-1408** for assistance.

Engine Maintenance

See engine owner's manual for instructions.

	CAUTION
Avoid prolonged or repeated skin contact with used motor oil.	
<ul style="list-style-type: none"> Used motor oil has been shown to cause skin cancer in certain laboratory animals. Thoroughly wash exposed areas with soap and water. 	



KEEP OUT OF REACH OF CHILDREN. DON'T POLLUTE. CONSERVE RESOURCES. RETURN USED OIL TO COLLECTION CENTERS.

Generator Maintenance

Generator maintenance consists of keeping the unit clean and dry. Operate and store the unit in a clean dry environment where it will not be exposed to excessive dust, dirt, moisture or any corrosive vapors. Cooling air slots in the generator must not become clogged with snow, leaves or any other foreign material.

NOTE: DO NOT use a garden hose to clean generator. Water can enter engine fuel system and cause problems. In addition, if water enters generator through cooling air slots, some of the water will be retained in voids and cracks of the rotor and stator winding insulation. Water and dirt buildup on the generator internal windings will eventually decrease the insulation resistance of these windings.

WARNING	
	Unintentional sparking can result in fire or electric shock.
WHEN ADJUSTING OR MAKING REPAIRS TO YOUR GENERATOR	
<ul style="list-style-type: none"> Disconnect the spark plug wire from the spark plug and place the wire where it cannot contact spark plug. 	
WHEN TESTING FOR ENGINE SPARK	
<ul style="list-style-type: none"> Use approved spark plug tester. DO NOT check for spark with spark plug removed. 	

Battery Maintenance

Other than float charging, described elsewhere, no maintenance is required for the battery. Keep the battery and terminals clean and dry.

IMPORTANT: Battery charging should be performed in a dry location, such as inside a garage.

To Clean the Generator

- Use a damp cloth to wipe exterior surfaces clean.

CAUTION	
Improper treatment of generator can damage it and shorten its life.	
<ul style="list-style-type: none"> DO NOT expose generator to excessive moisture, dust, dirt, or corrosive vapors. DO NOT insert any objects through cooling slots. 	

- Use a soft bristle brush to loosen caked on dirt or oil.
- Use a vacuum cleaner to pick up loose dirt.
- Use low pressure air (not to exceed 25 psi) to blow away dirt. Inspect cooling air slots and opening on generator. These openings must be kept clean and unobstructed.



STORAGE

The generator should be started at least once every seven days and allowed to run at least 30 minutes. If this cannot be done and you must store the unit for more than 30 days, use the following guidelines to prepare it for storage.

Generator Storage

- Clean the generator as outlined in "To Clean the Generator."
- Check that cooling air slots and openings on generator are open and unobstructed.



WARNING

Storage covers can be flammable.

- DO NOT place a storage cover over a hot generator.
- Let equipment cool for a sufficient time before placing the cover on the equipment.

Engine Storage

See engine owner's manual for instructions.

Other Storage Tips

- To prevent gum from forming in fuel system or on essential carburetor parts, add fuel stabilizer into fuel tank and fill with fresh fuel. Run the unit for several minutes to circulate the additive through the carburetor. The unit and fuel can then be stored for up to 24 months. Fuel stabilizer can be purchased locally.
- DO NOT store fuel from one season to another unless it has been treated as described above.
- Replace fuel container if it starts to rust. Rust and/or dirt in fuel can cause problems if it's used with this unit.
- Store unit in a clean and dry area.



TROUBLESHOOTING

Problem	Cause	Correction
No AC output is available, but engine is running.	<ol style="list-style-type: none">1. One of the circuit breakers is open.2. Fault in generator.3. Poor connection or defective cord set.4. Connected device is bad.	<ol style="list-style-type: none">1. Reset circuit breaker.2. Contact Generac service facility.3. Check and repair.4. Connect another device that is in good condition.
Engine runs good at no-load but "bogs" down" when loads are connected.	<ol style="list-style-type: none">1. Short circuit in a connected load.2. Generator is overloaded.3. Shorted generator circuit.	<ol style="list-style-type: none">1. Disconnect shorted electrical load.2. See "Don't Overload Generator".3. Contact Generac service facility.
Engine will not start; or starts and runs rough.	<ol style="list-style-type: none">1. Fuel valve is in the "Off" position.2. Failed battery.	<ol style="list-style-type: none">1. Turn fuel valve to "On" position.2. Replace battery.
Engine shuts down during operation.	Out of gasoline.	Fill fuel tank.
Engine lacks power.	Load is too high.	See "Don't Overload Generator".

GENERAC PORTABLE PRODUCTS OWNER EQUIPMENT WARRANTY POLICY
Effective November 1, 2004

LIMITED WARRANTY

"Generac Portable Products is a licensed trademark of Briggs & Stratton Power Products. Briggs & Stratton Power Products will repair or replace, free of charge, any part, or parts of the equipment** that are defective in material or workmanship or both. Transportation charges on parts submitted for repair or replacement under this warranty must be borne by purchaser. This warranty is effective for the time periods and subject to the conditions provided for in this policy. For warranty service, find your nearest Authorized service dealer by calling 1-800-270-1408. Warranty service may only be performed by a Briggs & Stratton Power Products Authorized service dealer.

THERE IS NO OTHER EXPRESS WARRANTY. IMPLIED WARRANTIES, INCLUDING THOSE OF MERCHANTABILITY AND FITNESS FOR A PARTICULAR PURPOSE, ARE LIMITED TO THE TIME PERIOD SPECIFIED, OR TO THE EXTENT PERMITTED BY LAW. ANY AND ALL IMPLIED WARRANTIES ARE EXCLUDED. LIABILITY FOR CONSEQUENTIAL DAMAGES UNDER ANY AND ALL WARRANTIES ARE EXCLUDED TO THE EXTENT EXCLUSION IS PERMITTED BY LAW. Some countries or states do not allow limitations on how long an implied warranty lasts, and some countries or states do not allow the exclusion or limitation of incidental or consequential damages, so the above limitation and exclusion may not apply to you. This warranty gives you specific legal rights and you may also have other rights that vary from country to country or state to state."

WARRANTY PERIOD*

PRODUCTS**	CONSUMER USE	COMMERCIAL USE
Pressure Washer	1 year	90 days
Portable Generator	2 years (2nd year parts only)	1 year

* The warranty period begins on the date of purchase by the first retail consumer or commercial end user, and continues for the period of time stated in the table above. "Consumer use" means personal residential household use by a retail consumer.

"Commercial use" means all other uses, including use for commercial, income producing or rental purposes. Once equipment has been used commercially, it shall thereafter be considered to be in commercial use for purposes of this warranty.

** The engine and starting batteries are warranted solely by the manufacturers of those products.

WARRANTY REGISTRATION IS NOT NECESSARY TO OBTAIN WARRANTY ON BRIGGS & STRATTON POWER PRODUCTS EQUIPMENT. SAVE YOUR PROOF OF PURCHASE RECEIPT. IF YOU DO NOT PROVIDE PROOF OF THE INITIAL PURCHASE DATE AT THE TIME WARRANTY SERVICE IS REQUESTED, THE MANUFACTURING DATE OF THE EQUIPMENT WILL BE USED TO DETERMINE THE WARRANTY PERIOD.

About your equipment warranty:

We welcome warranty repair and apologize to you for being inconvenienced. Any Authorized service dealer may perform warranty repairs. Most warranty repairs are handled routinely, but sometimes requests for warranty service may not be appropriate. For example, warranty service would not apply if equipment damage occurred because of misuse, lack of routine maintenance, shipping, handling, warehousing or improper installation. Similarly, the warranty is void if the manufacturing date or the serial number on the equipment has been removed or the equipment has been altered or modified. During the warranty period, the Authorized service dealer, at its option, will repair or replace any part that, upon examination, is found to be defective under normal use and service. This warranty will not cover following repairs and equipment:

- **Normal Wear:** Outdoor power equipment, like all mechanical devices, needs periodic parts, service and replacement to perform well. This warranty does not cover repair when normal use has exhausted the life of a part or the equipment.
- **Installation and Maintenance:** This warranty does not apply to equipment or parts that have been subjected to improper or unauthorized installation or alteration and modification, misuse, negligence, accident, overloading, overspeeding, improper maintenance, repair or storage so as, in our judgment, to adversely affect its performance and reliability. This warranty also does not cover normal maintenance such as adjustments, fuel system cleaning and obstruction (due to chemical, dirt, carbon or lime, etc.).
- **Other Exclusions:** Also excluded from this warranty are wear items such as quick couplers, oil gauges, belts, o-rings, filters, pump packing, etc., pumps which have been run without water supplied or damage or malfunctions resulting from accidents, abuse, modifications, alterations, or improper servicing or freezing or chemical deterioration. Accessory parts such as guns, hoses, wands and nozzles are excluded from the product warranty. This warranty excludes failures due to acts of God and other force majeure events beyond the manufacturers control. Also excluded is used, reconditioned, and demonstration equipment; equipment used for prime power in place of utility power and equipment used in life support applications.

BRIGGS & STRATTON POWER PRODUCTS GROUP, LLC
JEFFERSON, WISCONSIN, U.S.A.